

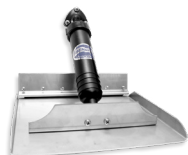

EXCEPTIONAL TRIM TAB SYSTEMS. UNMATCHED RELIABILITY.

BENNETT  **MARINE**

*Bennett Marine is a Division of
Yamaha Marine Systems Company, Inc.*



Benefits you can feel Reliability you can trust

CONTENTS

BOLT Electric Kits	4-5
Hydraulic & SLT Trim Tab Kits	6-7
Helm Controls	8-9
Actuators & Trim Planes (Tabs)	10
Trim Tab Usability Overview	11

For over half a century, boaters have enjoyed the tangible benefits of Bennett Marine's exceptionally durable and dependable marine products.

We're proud to say that boaters trust our brand. After all, we invented the world's first adjustable trim tab—and we've never stopped pushing forward, always striving to make better, more affordable systems with maximum performance. Experience the benefits—get Bennett on board and enjoy the ride!

Reduce bow rise, plane faster, correct listing.



4-5



6-7



8-9

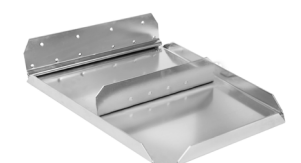

10

Lenco-to-BOLT Conversion Kit
CONTROLS & TABS SOLD SEPARATELY



This kit includes everything necessary for a cost-effective, quick, and easy upgrade from Lenco actuators to Bennett's exceptionally durable and dependable actuators. Bennett electric actuators are built to last, backed by a lifetime limited warranty.

- Works with Lenco "Standard Mount," "Standard Performance," and "Edge Mount" systems
- Plug-and-play connection to your existing standard Lenco controls (Determine compatibility at BennettTrimTabs.com/Lenco-to-Bolt)
- Simply replace the Lenco actuators with Bennett BOLT actuators using the existing drill holes
- No new holes to drill. Keep your existing trim tabs

PN #	YAMAHA #	DESCRIPTION
BOLTLKCON	6BT-50013-60-00	Lenco-to-BOLT Upgrade Kit (Controls & tabs not included)

Hydraulic-to-BOLT Conversion Kit
CONTROLS & TABS SOLD SEPARATELY



All you need for a quick and easy conversion from Bennett hydraulic actuators to Bennett BOLT electric actuators. BOLT actuators are exceptionally durable and dependable, backed by a lifetime limited warranty.

- Quick and easy conversion from standard Bennett hydraulic single actuator systems (A1101A / 6BT-50084-35-00), using your existing wiring, rocker switch, and trim tabs
- No rewiring or drilling of new holes required
- Plug-and-play connection to your existing standard Bennett Rocker Switch (ES2000 / 6BT-50030-16-00). Includes auto tab retraction and diagnostics relay module

PN #	YAMAHA #	DESCRIPTION
HYDBOLTCON	6BT-50040-42-00	Hydraulic-to-BOLT Conversion Kit

BOLT Electric Trim Tab Kits (12V)
CONTROLS SOLD SEPARATELY

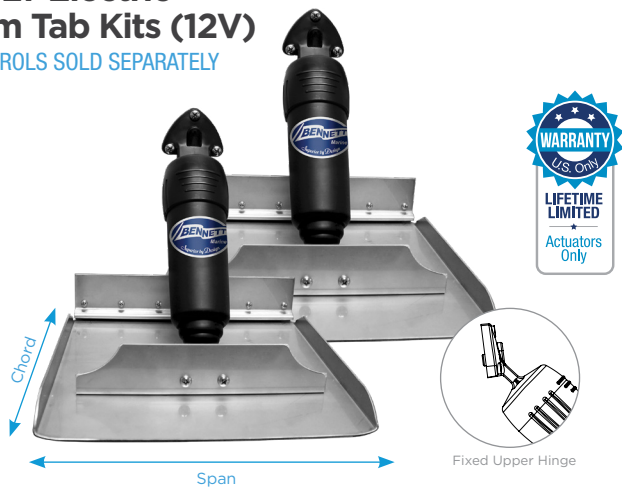

Balance loads, plane faster, increase efficiency and performance with Bennett BOLT Electric Trim Tab systems, built to outlast any electric trim tab system on the market.

Kits Include:

- (2) 12-volt fixed upper hinge actuators with 6-ft. wire harnesses and waterproof connectors (BEA2000 / 6BT-50012-02-00)
- (2) Stainless steel trim planes (tabs) and mounting plates
- (2) 20-ft. wire harnesses with waterproof connectors (BAW2020 / 6BT-50011-80-00)

BENNETT#	YAMAHA #	SPAN/CHORD	*TAB
BOLT124	6BT-50013-43-00	12"x4"	(P)
BOLT129	6BT-50013-44-00	12"x9"	(T)
BOLT189	6BT-50013-49-00	18"x9"	(T)
BOLT249	6BT-50013-52-00	24"x9"	(T)
BOLT1212	6BT-50013-38-00	12"x12"	(R)
BOLT1812	6BT-50013-47-00	18"x12"	(R)
BOLT2412	6BT-50013-51-00	24"x12"	(R)
*BOLTLTADJ	6BT-50013-59-00		
*BOLTLT	6BT-50013-57-00		

Features Include:

- Completely sealed upper hinge with no exposed wires

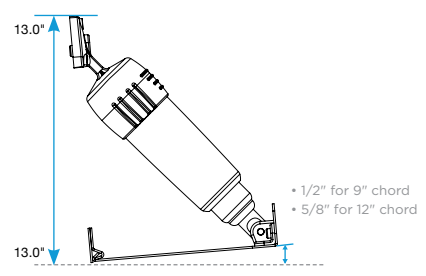

BOLT Electric - Edge Mount Limited Space Trim Tab Kits (12V)
CONTROLS SOLD SEPARATELY



Designed with an adjustable upper hinge for transoms with limited vertical space. Tabs turn up for added strength and feature piano-hinged backing plates. Requires less than 6.5" of vertical transom space to install.

Kits Include:

- (2) 12-volt adjustable upper hinge actuators with 6-ft. cables and waterproof connectors (BEA3000 / 6BT-50012-09-00)
- (2) Stainless steel trim planes (tabs) and mounting plates
- (2) 20-ft. wire harnesses with waterproof connectors (BAW2020 / 6BT-50011-80-00)

PN#	YAMAHA #	SPAN/CHORD	*TAB
BOLT612ED	6BT-50013-53-00	6"x12"	(P)
BOLT912ED	6BT-50013-54-00	9"x12"	(P)
BOLT1212ED	6BT-50013-41-00	12"x12"	(P)
BOLTLTADJ	6BT-50013-59-00	12"x12"	(P)
* Tabs not included			

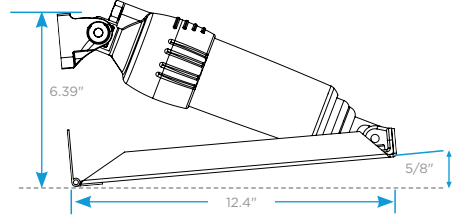

EDGE MOUNT BOLT SETS	VERTICAL HEIGHT REQUIREMENT PER TRANSOM ANGLE				
	0 DEG	5 DEG	10 DEG	15 DEG	17 DEG
BOLT612ED, BOLT912ED, BOLT1212ED	6.5" (16.51cm)	7.8" (19.812cm)	9.2" (23.368cm)	10.7" (27.178cm)	11.3" (28.702cm)

BOLT Short Electric Actuator Sets NEW

Designed specifically for boat builder customers needing to fit limited-space transom pockets, this set features the new SEA3000 (6BT-50111-72-00) short electric actuators.

PN#	YAMAHA #	SPAN/CHORD	*TAB	CONTROLS SOLD SEPARATELY
BOLT129SML	6BT-50111-70-00	12"x9"	(T)	



BOLT 12x16 Heavy Duty Trim Tab System
CONTROLS SOLD SEPARATELY



Designed for rougher conditions and higher speeds with extremely durable 12-gauge, electro-polished stainless steel, featuring a full-profile backing plate, and up-fins for added strength.

Kits Include:

- (2) 12-volt adjustable upper hinge actuators with 6-ft. wire harnesses and waterproof connectors (BEA3000 / 6BT-50012-09-00)
- (2) 12" span x 16 chord" heavy-duty tapered electro-polished trim tabs
- (2) 20-ft. wire harnesses with waterproof connectors (BAW2020 / 6BT-50011-80-00)

PN#	YAMAHA #	SPAN/CHORD	*TAB
BOLT1216HD	6BT-50104-81-00	12"x16"	(P)



R4 anodes included to prevent electrolysis damage

Features Include:

- Requires less than 11" of vertical transom height
- Full-profile 12-gauge backing plate and up-fins for added strength

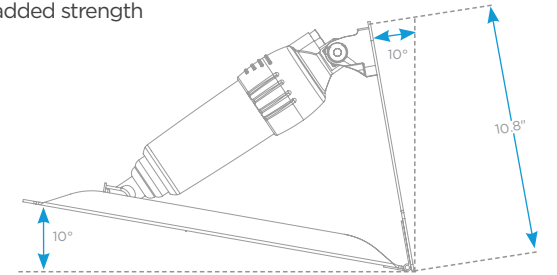

Basic Diagrams

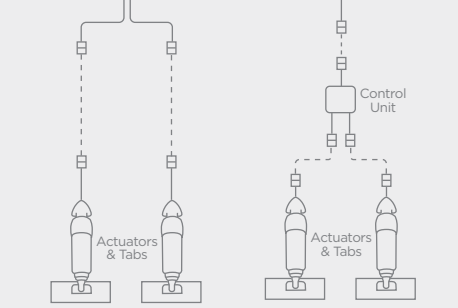

Tab Styles *

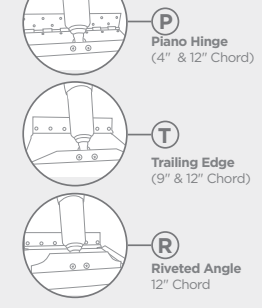

Helm Control Options (Sold separately) See page 8 for detailed control information



Standard Hydraulic Trim Tab Kits & Sport Limited-Space Kits (M80/M120)

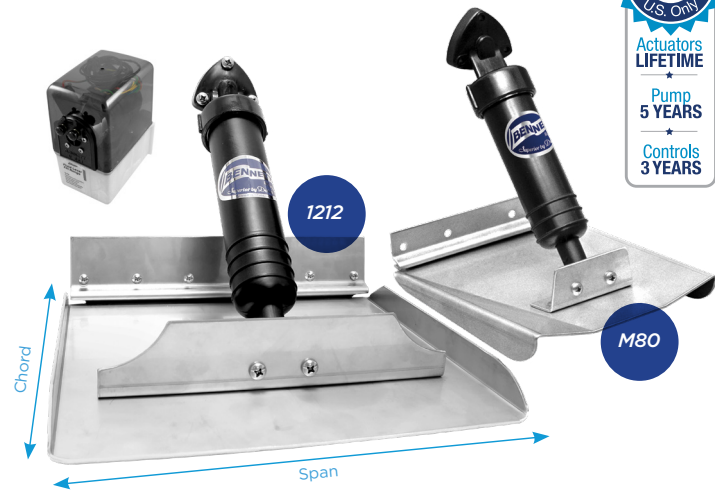

Hydraulic trim tabs are known for power, precision, and durability. Get the most from your boat, no matter what the load, speed, or sea conditions. Using the helm control, you can adjust the tabs individually or in unison to create the perfect cruising attitude. Increase speed and fuel economy, smooth a rough ride, and get on plane faster.

Kits Include:

- (2) Trim plane assemblies
- (2-4) Hydraulic actuators (A1101A / 6BT-50084-35-00)
- (1) Hydraulic power unit (V351HPUID / 6BT-50086-73-00)
- Hydraulic tubing and hardware
- Optional helm control (See below)

Features Include:

- Get on plane fast, and stay on plane at intermediate speeds
- Correct listing and uneven loads
- Improve visibility and safety
- Reduce pounding and eliminate porpoising
- Low maintenance, long-term value, and ease of service
- Exclusive transom mount interlocking tab design
- Sport batwing option (M80/M120) provides 30% more lift for limited-space installations
- Bottom and piano hinge mounts are available for custom order



Kits without Control Included

PN#	YAMAHA #	SPAN/CHORD	*TAB	*ACT.
129	6BT-50000-73-00	12"x9"	T	2
189	6BT-50001-82-00	18"x9"	T	2
249	6BT-50002-87-00	24"x9"	T	2
309	6BT-50003-28-00	30"x9"	T	2
369	6BT-50003-68-00	36"x9"	T	2
429	6BT-50004-04-00	42"x9"	T	2
489	6BT-50004-19-00	48"x9"	T	2
549	6BT-50004-32-00	54"x9"	T	2
1212	6BT-50000-52-00	12"x12"	R	2
1812	6BT-50001-41-00	18"x12"	R	2
2412	6BT-50002-65-00	24"x12"	R	2
3012	6BT-50003-09-00	30"x12"	R	2
3612	6BT-50003-56-00	36"x12"	R	2
4212	6BT-50003-94-00	42"x12"	R	2
4812	6BT-50004-08-00	48"x12"	R	2
5412	6BT-50004-27-00	54"x12"	R	2
6012	6BT-50004-37-00	60"x12"	R	2
6612	6BT-50004-60-00	66"x12"	R	2
7212	6BT-50004-67-00	72"x12"	R	2

*Actuators per tab

Complete Kits with Rocker Control

PN#	YAMAHA #	SPAN/CHORD	*TAB	*ACT.
M80	6BT-50042-32-00	8"x10"	S	2
M120	6BT-50042-22-00	10"x12"	S	2
129E	6BT-50000-77-00	12"x9"	T	2
189E	6BT-50001-87-00	18"x9"	T	2
249E	6BT-50002-89-00	24"x9"	T	2
309E	6BT-50003-29-00	30"x9"	T	2
369E	6BT-50003-71-00	36"x9"	T	2
429E	6BT-50004-05-00	42"x9"	T	2
489E	6BT-50004-21-00	48"x9"	T	2
549E	6BT-50004-34-00	54"x9"	T	2
1212E	6BT-50000-57-00	12"x12"	R	2
1812E	6BT-50001-48-00	18"x12"	R	2
2412E	6BT-50002-72-00	24"x12"	R	2
3012E	6BT-50003-18-00	30"x12"	R	2
3612E	6BT-50003-63-00	36"x12"	R	2
4212E	6BT-50003-99-00	42"x12"	R	2
4812E	6BT-50004-10-00	48"x12"	R	2
5412E	6BT-50004-29-00	54"x12"	R	2
6012E	6BT-50004-38-00	60"x12"	R	2
6612E	6BT-50004-61-00	66"x12"	R	2
7212E	6BT-50004-68-00	72"x12"	R	2

*Actuators per tab

Complete Kits with All-in-one Control

PN#	YAMAHA #	SPAN/CHORD	*TAB	*ACT.
M800BI	6BT-50110-78-00	8"x10"	S	2
M1200BI	6BT-50110-79-00	10"x12"	S	2
1290BI	6BT-50110-87-00	12"x9"	T	2
1890BI	6BT-50110-85-00	18"x9"	T	2
2490BI	6BT-50110-88-00	24"x9"	T	2
12120BI	6BT-50110-89-00	12"x12"	R	2
18120BI	6BT-50110-90-00	18"x12"	R	2
24120BI	6BT-50110-91-00	24"x12"	R	2

*Actuators per tab

Complete Kits with AutoTrim Pro

PN#	YAMAHA #	SPAN/CHORD	*TAB	*ACT.
M80ATP	6BT-50042-34-00	8"x10"	S	2
M120ATP	6BT-50042-23-00	10"x12"	S	2
129ATP	6BT-50000-76-00	12"x9"	T	2
189ATP	6BT-50001-85-00	18"x9"	T	2
249ATP	6BT-50002-88-00	24"x9"	T	2
1212ATP	6BT-50000-53-00	12"x12"	R	2
1812ATP	6BT-50001-42-00	18"x12"	R	2
2412ATP	6BT-50002-66-00	24"x12"	R	2

*Actuators per tab

Performance Electro-polished Trim Tab Kits



Enjoy the electro-polished finish of Performance Tabs. Manufactured with heavy-gauge reinforced stainless steel and powerful hydraulic actuators. Performance Tabs combine strength, durability, and good looks to achieve your boat's maximum potential.

Features Include:

- Get on plane fast and stay on plane at intermediate speeds
- Correct listing and uneven loads
- Reduce pounding and eliminate porpoising
- Improve visibility and safety
- Low maintenance with long-term value

Kits Include:

- (1) Helm control (Rocker, EIC, or ATP) (See page 8-9)
- (2) Trim plane assemblies
- (2-4) Hydraulic actuators
- (1) Hydraulic power unit (V351HPUID / 6BT-50086-73-00)
- Hydraulic tubing and hardware



Complete Kits With AutoTrim Pro

PN#	YAMAHA #	SPAN/CHORD	*TAB	*ACT.
ST9ATP	6BT-50085-45-00	12"x9"	T	2
ST12ATP	6BT-50063-02-00	12"x12"	R	2
ST16ATP	6BT-50063-09-00	12"x16"	R	2

*Actuators per tab

Complete Kits with Rocker

PN#	YAMAHA #	SPAN/CHORD	*TAB	*ACT.
ST9	6BT-50063-16-00	12"x9"	T	2
ST12	6BT-50063-01-00	12"x12"	R	2
ST16	6BT-50063-07-00	12"x16"	R	2

*Actuators per tab

Complete Kits with All-in-one Control

PN#	YAMAHA #	SPAN/CHORD	*TAB	*ACT.
ST90BI	6BT-50111-76-00	12"x9"	T	2
ST120BI	6BT-50111-14-00	12"x12"	R	2
ST160BI	6BT-50111-15-00	12"x16"	R	2

*Actuators per tab

Self-Leveling Tabs (SLT)

SPRING-LOADED. NO HELM CONTROLS NEEDED.



A simple, durable, and affordable trimming solution for smaller boats. Quick and easy installation with nothing to do inside the boat—just mount the actuators and trim tabs on the transom and enjoy the benefits.

Kits Include:

- (2) 14-gauge stainless steel tabs with Bennett's exclusive interlocking hinge
- (2) Strong, durable, spring-loaded actuators
- All stainless steel hardware

Features Include:

- Three mounting options to easily change lift
- Plane at lower speeds
- Improve fuel efficiency
- Eliminate porpoising and chine walking
- Improve your hole shot
- Reduce engine laboring and improve fuel efficiency



PN#	YAMAHA #	DESCRIPTION
SLT6	6BT-50059-26-00	SLT6 - 6"x 8" Spring-loaded Tabs for Small boats up to 16' (60 lb. spring)
SLT10	6BT-50058-93-00	SLT10 - 10"x10" Spring-loaded Tabs for Small boats 17'-20' (90 lb. spring)

▶ Watch the video BennettTrimTabs.com/SLT

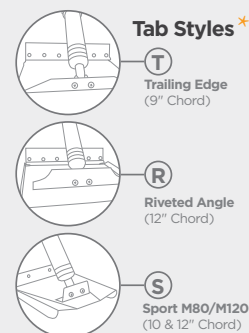
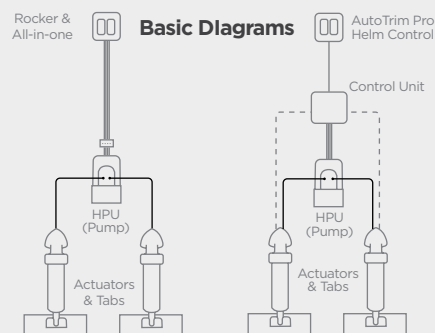

Helm Control Options

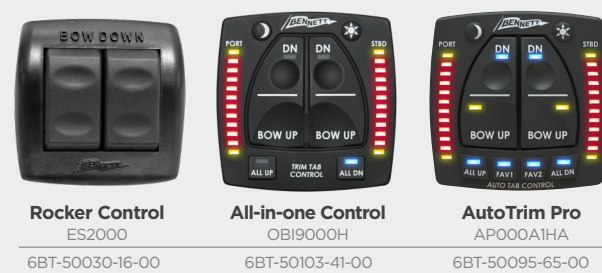

See page 8 for detailed information and more set retrofit options.

Rocker Control ES2000 6BT-50030-16-00
All-in-one Control OBI9000H 6BT-50103-41-00
AutoTrim Pro APO00A1HA 6BT-50095-65-00

Bennett part numbers listed first. Yamaha Part Numbers listed below.

Rocker Switch Control

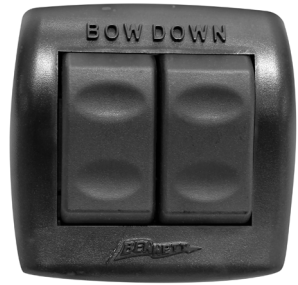

This economic control is ergonomically designed, water resistant, and provides a distinctive “click” when the trim tabs are engaged.

Basic System Diagram

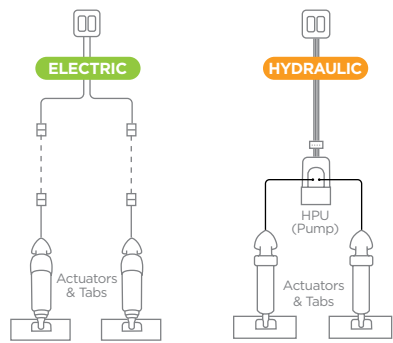

PN#	YAMAHA #	DESCRIPTION
ES2000	6BT-50030-16-00	H Rocker Switch for Hydraulic Systems
BRC4000	6BT-50017-40-00	E Rocker Switch for Electric Systems

All-in-one Indicator Control Also known as OBI Control and Integrated Helm Control



An attractive and user-friendly, stand-alone helm control without the need for an external control unit. The functionality and “brains” of the control unit are engineered directly into a single, space-saving, and simple-to-install keypad.

Included:

- (1) Helm Control w/3-ft. cable and waterproof cables
- Included with hydraulic only**
- (2) Upper Hinge Screw-on Sensors



Features Include:

- Convenient “All Up” and “All Down” buttons
- Trim tab position LEDs always show you where your tabs are
- Auto tab retraction (tabs retract up when the ignition is powered off)
- Easy-to-install single lock nut design
- Compatible with other trim tab system brands
- Easily upgrade from hydraulic systems without tab position indication

Basic System Diagram

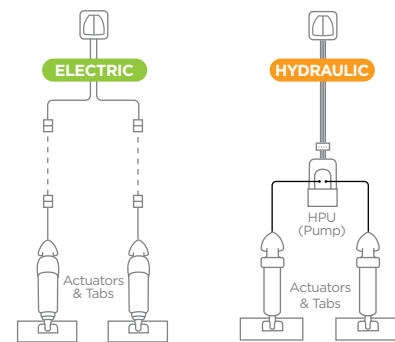

PN#	YAMAHA #	DESCRIPTION
0BI9000H	6BT-50103-41-00	H All-in-one Indicator Control for Hydraulic Systems
0BI9000E	6BT-50103-40-00	E All-in-one Indicator Control for Electric Systems

AutoTrim Pro Automatic Control



Put Your Trim Tabs on Autopilot



AutoTrim Pro is an all-in-one auto trim tab control system designed for boats of all sizes—packing a boatload of essential features into an easy-to-use, space-saving keypad. Reduce bow rise, improve visibility, correct listing—automatically.

Kits Include:

- (1) ATP helm display w/3-ft. cable (ATPDISP)
- (1) ATP control unit w/3-ft. cable (ATPHYDCTRL or ATPBOLTCTRL)
- (1) 25' extension cable (BHW4025)
- Required hardware



Features Include:

- Compatible with Bennett hydraulic or electric trim tab systems and most non-Bennett trim tab systems
- Auto trim tab control with favorite buttons
- Take manual control of your trim tabs at any time
- Trim tab position indication with adjustable L.E.D.s
- Auto tab retraction when ignition is powered off

Basic System Diagram

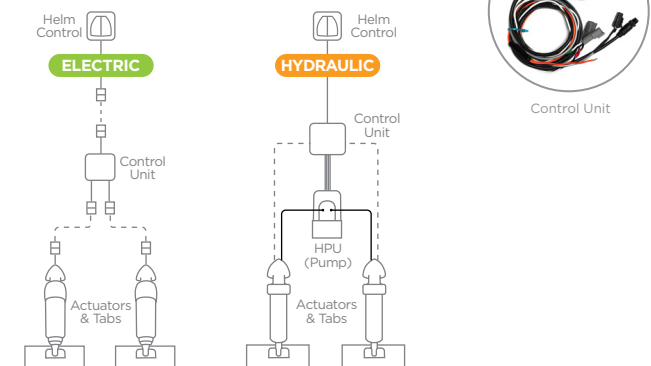

PN#	YAMAHA #	DESCRIPTION
AP000A1HA	6BT-50095-65-00	H AutoTrim Pro for Hydraulic Systems
AP000A1BC	6BT-50095-66-00	E AutoTrim Pro for Electric Systems

Joystick Helm Control ELECTRIC ONLY



Charles Bennett originally introduced adjustable trim tabs with joystick controls inspired by aircraft ailerons and controls. The joystick helm control acclaimed for its instinctive and intuitive interface is back—with a sleek redesign!

Features Include:

- Easily trim your vessel like a boss!
- Instinctive and intuitive feel and operation
- Connects directly to your actuators with plug-and-play connectors
- Auto tab retraction (tabs retract up when the ignition is powered off)
- Compatible with other trim tab system brands



Basic System Diagram



PN#	YAMAHA #	DESCRIPTION
JOY1000	6BT-50100-19-00	E Joystick Helm Control for Electric Systems



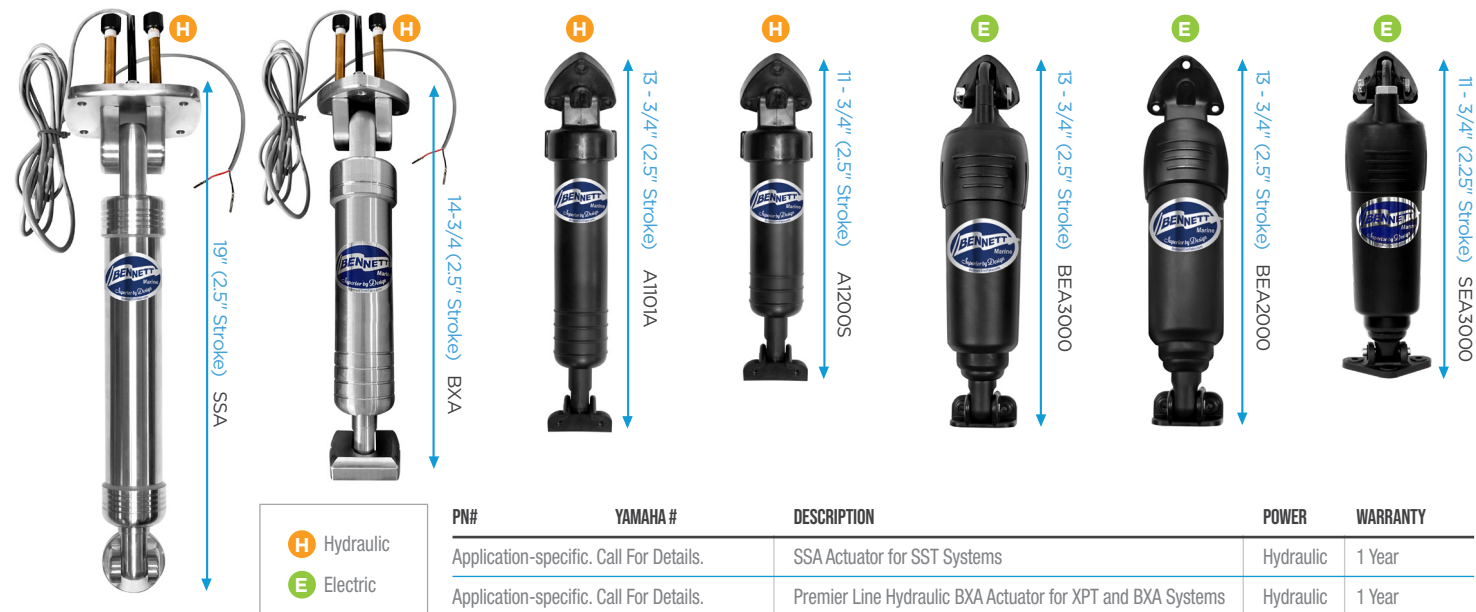

PN#	YAMAHA #	DESCRIPTION	POWER	WARRANTY
Application-specific. Call For Details.		SSA Actuator for SST Systems	Hydraulic	1 Year
Application-specific. Call For Details.		Premier Line Hydraulic BXA Actuator for XPT and BXA Systems	Hydraulic	1 Year
A1101A	6BT-50084-35-00	Standard Length Hydraulic Actuator	Hydraulic	Lifetime Limited
A1200S	6BT-50084-79-00	Short Hydraulic Actuator	Hydraulic	Lifetime Limited
BEA3000	6BT-50012-09-00	BOLT Electric Actuator with Adjustable Upper Hinge	Electric	Lifetime Limited
BEA2000	6BT-50012-02-00	BOLT Electric Actuator with Fixed Upper Hinge	Electric	Lifetime Limited
SEA3000	6BT-50111-72-00	Short Electric Actuator	Electric	Lifetime Limited

Actuator variations not shown: A1101CP (Actuator with 30' sensor wire for TPI or NMEA), A1101CPEIC (Actuator with 10' sensor wire for EIC), SLT actuators

Actuators

Bennett actuators are built to last, maintenance-free, and backed by Bennett's legendary support.

Trim Plane Assemblies

Bennett Marine's durable and dependable trim planes are made of high quality 12 or 14-gauge 304 stainless steel. Each trim plane assembly (for one side of the boat) includes a trim plane, hinge plate, and backing plate.

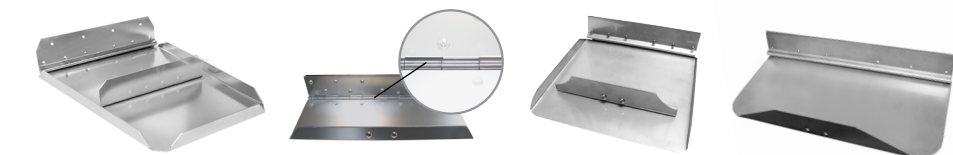
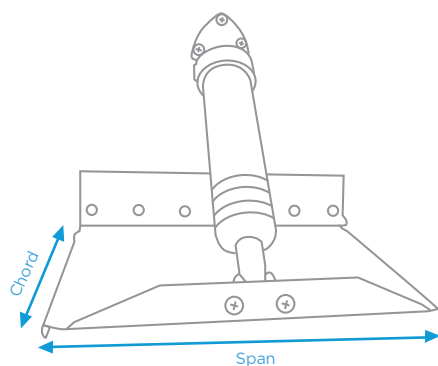

Performance			Piano Hinge			Riveted Angle			Trailing Edge		
PN#	YAMAHA #	SPAN/CHORD	PN#	YAMAHA #	SPAN/CHORD	PN#	YAMAHA #	SPAN/CHORD	PN#	YAMAHA #	SPAN/CHORD
TPAST9	6BT-50073-38-00	12"x9"	TPA124	6BT-50069-25-00	12"x4"	TPA1212	6BT-50068-93-00	12"x12"	TPA129	6BT-50069-27-00	12"x9"
TPAST12	6BT-50073-35-00	12"x12"	TPA912ED	6BT-50070-94-00	9"x12"	TPA1812	6BT-50069-62-00	18"x12"	TPA189	6BT-50069-70-00	18"x9"
TPAST16P	6BT-50073-36-00	12"x16"	TPA1212ED	6BT-50068-99-00	12"x12"	TPA2412	6BT-50070-01-00	24"x12"	TPA249	6BT-50070-13-00	24"x9"
TPAST16S	6BT-50073-37-00	12"x16"				TPA3012	6BT-50070-18-00	30"x12"	TPA309	6BT-50070-29-00	30"x9"
						TPA3612	6BT-50070-36-00	36"x12"	TPA369	6BT-50070-44-00	36"x9"
						TPA4212	6BT-50070-52-00	42"x12"	TPA429	6BT-50070-57-00	42"x9"
						TPA4812	6BT-50070-63-00	48"x12"	TPA489	6BT-50070-66-00	48"x9"
						TPA5412	6BT-50070-73-00	54"x12"	TPA549	6BT-50070-78-00	54"x9"
						TPA6012	6BT-50070-82-00	60"x12"			
TPAM80	6BT-50072-10-00	8"x10"	TPA6612	6BT-50070-87-00	66"x12"						
TPAM120	6BT-50072-09-00	10"x12"	TPA7212	6BT-50070-89-00	72"x12"						

Assembly Components

Trim Plane Assemblies (TPA) consist of 3 main components, which can all be ordered separately. When ordering separately, simply swap "TPA" with the acronyms below. For example: *HP12* is a 12" Hinge Plate Only.

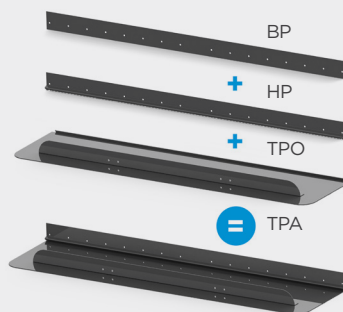

- **BP** - Backing Plate Only
- **HP** - Hinge Plate Only
- **TPO** - Trim Plane Only



Sport Tabs (M80/M120)

PN#	YAMAHA #	SPAN/CHORD
TPA6012	6BT-50070-82-00	60"x12"
TPA6612	6BT-50070-87-00	66"x12"
TPA7212	6BT-50070-89-00	72"x12"

A BETTER RIDE

Properly sized trim tabs improve the performance of your boat by adjusting the running angle of your vessel. Bennett Marine trim tabs help you get on plane faster, correct listing to one side, improve visibility, and increase your fuel efficiency.

- Get up on plane quickly, and plane at lower speeds
- Increase performance and fuel efficiency
- Increase visibility
- Adjust the boat's attitude for changes in speed, sea conditions, and shifting weight
- Correct listing on either side of the boat

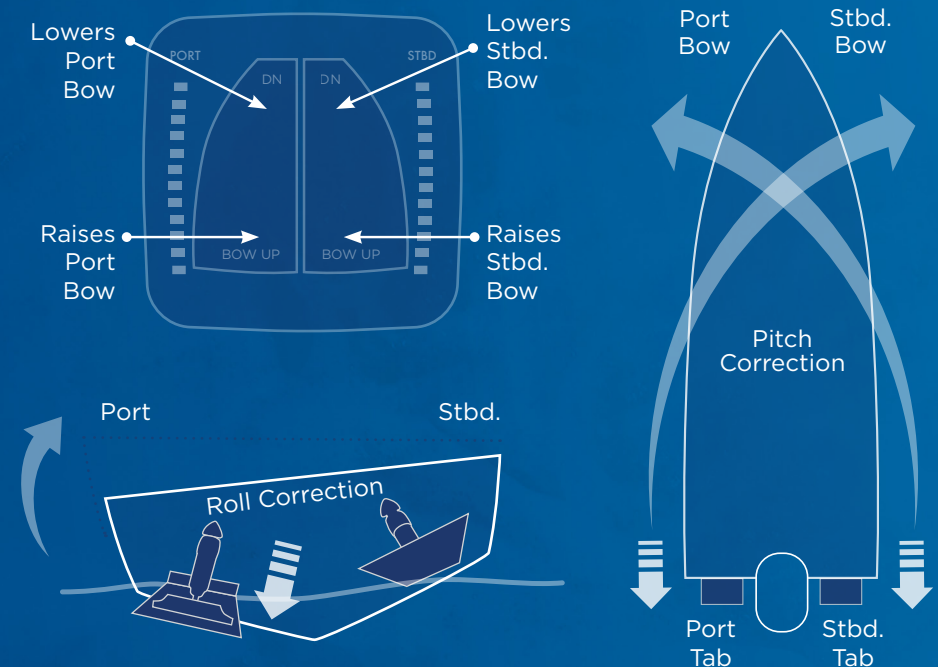

Learn more at BennettTrimTabs.com/Guide

- Key features & benefits
- Sizing guidelines
- System comparison
- Install tips, and more

How Trim Tabs Work

When the tabs are deployed downward, the water force on the trim tab surface creates upward pressure, raising the stern and lowering the bow. The port trim tab lowers the starboard bow, and the starboard trim tab lowers the port bow. The control is intuitively wired so that all you have to do is press the button in the direction you want the bow to move.

When the port tab is lowered independently, an upward force at the port stern of the boat is created. The inverse applies when lowering the starboard tab independently.



Without Trim Tabs

With Trim Tabs

The Undisputed Leader

In 1960, Charles Bennett invented the first adjustable trim tab system. Since then, we've continued to push forward and have introduced a myriad of industry-changing innovations, like auto tab control, trim tab position indication, and NMEA2000 integration.

We've worked with the best boat builders and enthusiasts in the world to create a host of exceptional products, and we back them with the best warranty in the industry. Bennett Marine is also the only manufacturer that offers both electric and hydraulic trim tab systems.



**ENJOY
THE RIDE**

Benefits you can feel. Quality you can trust.